

**DETAIL A (8 PL.)  
(SLOT DETAIL)**

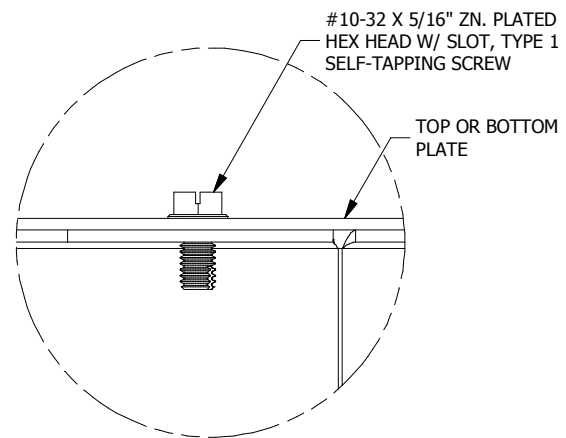

**DETAIL B (6 PL.)  
(ASSM. DETAIL)**

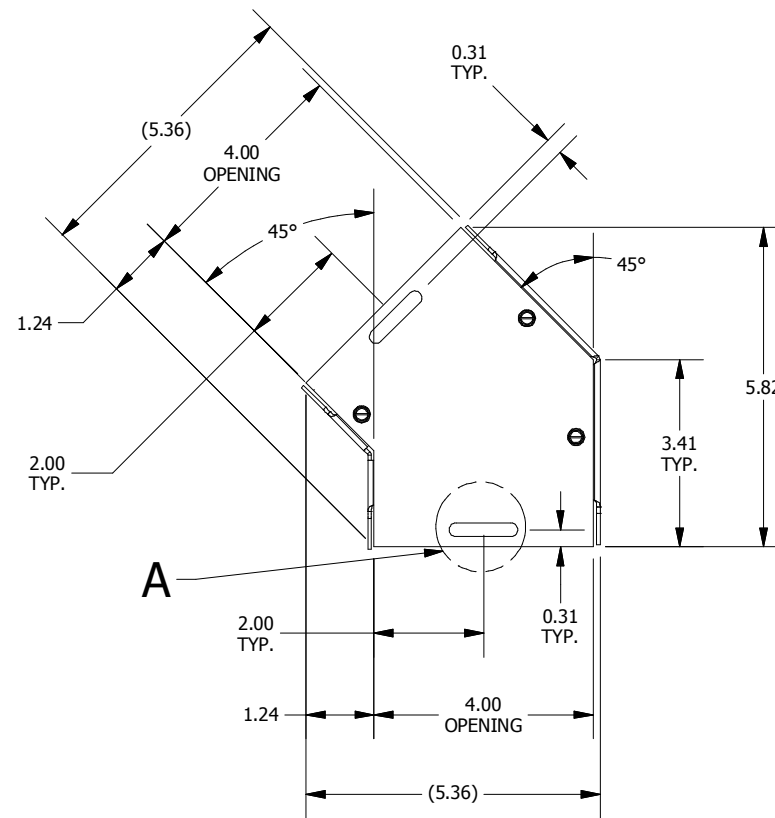

**TOP VIEW**

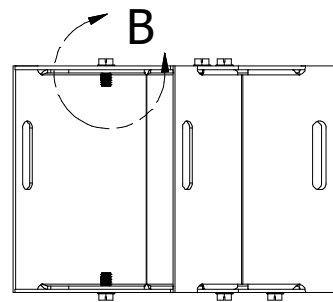
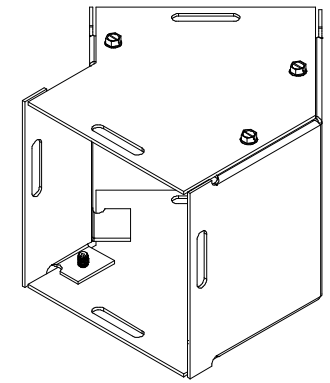

**SIDE VIEW**

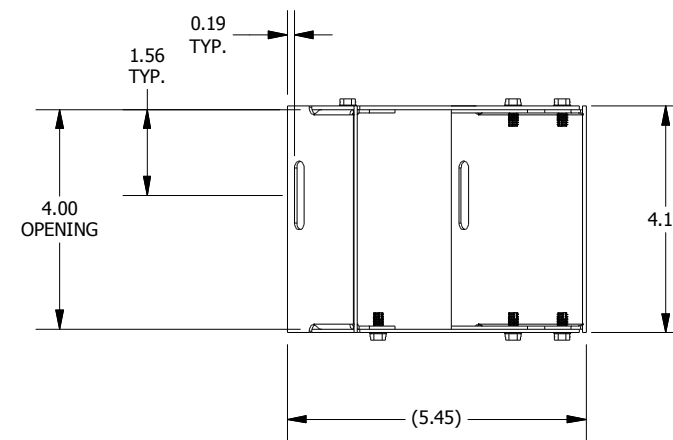

**FRONT VIEW**

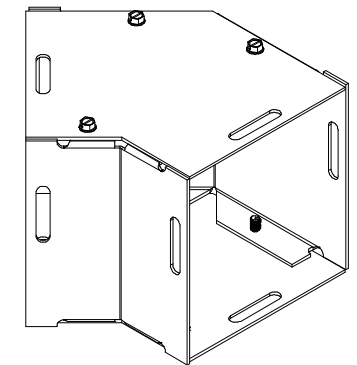

PART#: L040445  
(DATA SUBJECT TO CHANGE WITHOUT NOTICE)

THIS DRAWING IS PROPERTY OF HUBBELL INC. WIEGMANN  
ALL INFORMATION IS PROPRIETARY AND NOT TO BE DUPLICATED